



STA..3..

STP..3..

ACVATIX™

Electrothermal actuators

for radiators, small and Combi valves

STA..3..
STP..3..

- Operating voltage AC/DC 24 V, 2-point positioning signal or PDM (pulse-duration modulation)
- Operating voltage AC 230 V, 2-point positioning signal
- Operating voltage AC 24 V, Positioning signal DC 0...10 V
- Positioning force 100 N
- Standard version with connecting cable (1 m / 0.8 m)
- Actuators without connecting cable used together with:
 - Connecting cable for up to 15 meters, halogen-free also available
 - Connecting cable with LED operating indication
 - Connecting cable with auxiliary switch or DC 0...10 V module
- Variants supporting synchronous operation of multiple actuators switched in parallel
- 270° visible position indication
- Mounting using a sliding sleeve lock (bayonet)
- Adaptor for mounting on third-party valves
- Dismantling protection (optional)
- Automatic adaption of close – dimension
- IP54
- Robust, maintenance-free, noise-free

- Used in interior rooms
- For Siemens valves:
 - Radiator valves VDN.., VEN.. and VUN..
 - Small valves VD1..CLC, V..P47..
 - Zone valves V..I46..
 - Combi valves VPP46.., VPI46..
 - MiniCombiValves (MCV) VPD.. and VPE..
- For third-party valves
 - Direct assembly: Heimeier, Cazzaniga, Oventrop M30 x 1.5, Honeywell-Braukmann and MNG
 - Mounting using an adapter: See "Type summary/Accessories" on page 3.
- For additional valves, see "Equipment combinations" on page 5.

Fast selection

The product range STA..3.. / STP..3.. covers the widest range of equipment combinations and applications. The cable in a standard length is included with actuators using connecting cables. Actuators without connecting cables can be used in combination with the appropriate cables, see "Accessories/connecting cables", page 4. See page 5 for additional accessories.

Examples

The following examples simplify fast selection of actuators appropriate to the application (including accessories).

<i>Starting point</i>	<i>Procedure for quick selection</i>
<p>Example 1</p> <ul style="list-style-type: none"> • Valves used: VVP47.. • Connecting cable length: Approx. 0.6 m • Operating voltage: AC 230 V 	<ol style="list-style-type: none"> 1. See "Equipment combinations" on page 5. Correct actuator (group): STP.. 2. See "Type summary" on page 3, Table "Actuator with connecting cable": Actuator STP23 (with 1 m connecting cable)
<p>Example 2</p> <ul style="list-style-type: none"> • Valves used: VDN.. • Connecting cable length: Ca. 5 m • Operating voltage: AC 24 V • Color: Black 	<ol style="list-style-type: none"> 1. See "Equipment combinations" on page 5 Actuator (group): STA.. 2. No proper device can be found in the "Type summary" on page 3, Table "Actuator with connecting cable". 3. Select an actuator without connecting cable due to the desired color and length of the connecting cable: STA73B/00 4. Select the appropriate connecting cable from the table "Accessories/connecting cable", page 4: ASY23L50B

Type summary

Actuators with connecting cable

Type	Item No.	Position de-energized ¹⁾	Operating voltage	Positioning signal			Positioning time	Connecting cable	Weight
				2-position	PDM ²⁾	DC 0...10 V			
STA73	S55174-A100	NC	AC/DC 24 V	2-position	PDM ²⁾		270 s	1 m	181 g
STA23	S55174-A101	NC	AC 230 V	2-position ⁴⁾			210 s	1 m	181 g
STP73	S55174-A102	NO	AC/DC 24 V	2-position	PDM ²⁾		270 s	1 m	177 g
STP23	S55174-A103	NO	AC 230 V	2-position ⁴⁾			210 s	1 m	177 g
STA63	S55174-A104	NC	AC 24 V	DC 0...10 V			30 s	1 m	205 g
STP63	S55174-A105	NO	AC 24 V	DC 0...10 V			30 s	1 m	201 g
STA73HD ³⁾	S55174-A106	NC	AC/DC 24 V	2-position			270 s	0.8 m	174 g
STA23HD ³⁾	S55174-A107	NC	AC 230 V	2-position			210 s	0.8 m	174 g

¹⁾ NC = Normally Closed = (valve) powerless closed (with regard to radiator valves, VPP46../VPI46.. and VVI46../VXI46).

NO = Normally Open = (valve) powerless open (with regard to V..P47..)

²⁾ Pulse Duration Modulation together with Desigo room controllers and other Siemens controllers according to their data sheet. Not suitable for parallel run

³⁾ For floor heating distributors

⁴⁾ Pulse Duration Modulation (PDM) possible with Siemens Thermostats where explicitly stated in the thermostats data sheet. Not suitable for parallel run in connection with PDM

Actuators without connecting cables

(see "Accessories" for proper cables)

Type	Item No.	Position de-energized. ¹⁾	Operating voltage	Pos. signal / pos.time ²⁾			Cable group	Weight
				2-position	PDM	DC 0...10 V		
Version in white RAL 9016								
STA73/00 ⁵⁾	S55174-A109	NC	AC/DC 24 V	270 s		30 s	1, 2, 7, 9	133 g
STA23/00	S55174-A110	NC	AC 230 V	210 s	–	–	1, 7	133 g
STP73/00 ⁵⁾	S55174-A111	NO	AC/DC 24 V	270 s		30 s	1, 3, 8, 9	129 g
STP23/00	S55174-A112	NO	AC 230 V	210 s	–	–	1, 8	129 g
STA73PR/00 ³⁾	S55174-A115	NC	AC/DC 24 V	270 s		–	1, 7, 9	133 g
STP73PR/00 ³⁾	S55174-A116	NO	AC/DC 24 V	270 s		–	1, 8, 9	129 g
STA73MP/00 ⁴⁾	S55174-A113	NC	AC/DC 24 V	270 s		30 s	1, 7, 9	195 g
STA23MP/00 ⁴⁾	S55174-A114	NC	AC 230 V	210 s	–	–	1, 7	195 g

Version in black RAL 9005

STA73B/00	S55174-A117	NC	AC/DC 24 V	270 s		30 s	4, 5	133 g
STA23B/00	S55174-A118	NC	AC 230 V	210	–	–	4	133 g
STP73B/00	S55174-A119	NO	AC/DC 24 V	270 s		30 s	4, 6	129 g
STP23B/00	S55174-A120	NO	AC 230 V	210 s	–	–	4	129 g

¹⁾ NC = Normally Closed = (valve) powerless closed (with regard to radiator valves, VPP46../VPI46.. and VVI46../VXI46).

NO = Normally Open = (valve) powerless open (with regard to V..P47..)

²⁾ At an ambient temperature of 20 °C.

³⁾ Suitable for parallel operation even in connection with PDM (Pulse Duration Modulation)

⁴⁾ Packaging unit: 50 pieces (OEM)

⁵⁾ In connection with an ASY6AL.. resp. ASY6PL.. DC 0...10 V connection cable/module, the operating voltage is limited to AC 24 V only.

Accessories

Connecting cable/connecting cable with function module

Type	Item No.	Cable group	Length [m]	Weight [g]	Assembled with	Cable coating	Positioning signal	Operating voltage		Color														
								STA23.. STP23..	STA73.. STP73..															
ASY23L08	S55174-A121	1	0,8	42	-	PVC	2-position	AC 230 V	AC/DC 24 V	White														
ASY23L10	S55174-A122		1	48																				
ASY23L20	S55174-A123		2	81																				
ASY23L30	S55174-A124		3	139																				
ASY23L40	S55174-A125		4	181																				
ASY23L50	S55174-A126		5	223																				
ASY23L60	S55174-A127		6	266																				
ASY23L70	S55174-A128		7	308																				
ASY23L100	S55174-A129		10	435																				
ASY23L150	S55174-A130		15	646																				
ASY23L30B	S55174-A131	4	3	139	Function module DC 0...10 V	PVC	DC 0...10 V	-	AC 24 V	Black														
ASY23L50B	S55174-A132		5	223																				
ASY23L100B	S55174-A133		10	435																				
ASY23L20HF	S55174-A134	1	2	100						Halogen-free	DC 0...10 V	-	AC 24 V	White										
ASY23L50HF	S55174-A135		5	218																				
ASY23L100HF	S55174-A136		10	466																				
ASY6AL20	S55174-A137	2	2	72						Function module DC 0...10 V					PVC	DC 0...10 V	-	AC 24 V	White					
ASY6AL50	S55174-A138		5	131																				
ASY6AL70	S55174-A139		7	176																				
ASY6PL20	S55174-A140	3	2	72															Function module DC 0...10 V	PVC	DC 0...10 V	-	AC 24 V	Black
ASY6PL50	S55174-A141		5	131																				
ASY6PL70	S55174-A142		7	176																				
ASY6AL20B	S55174-A143	5	2	72	Function module DC 0...10 V	PVC	DC 0...10 V	-	AC 24 V															Black
ASY6AL50B	S55174-A144		5	131																				
ASY6AL70B	S55174-A145		7	176																				
ASY6AL20HF	S55174-A147	2	2	61							Function module DC 0...10 V	Halogen-free	DC 0...10 V	-										AC 24 V
ASY6AL50HF	S55174-A148		5	129																				
ASY6AL70HF	S55174-A149		7	174																				
ASY6PL20HF	S55174-A150	3	2	61						Function module DC 0...10 V					Halogen-free	DC 0...10 V	-	AC 24 V						
ASY6PL50HF	S55174-A151		5	129																				
ASY6PL70HF	S55174-A152		7	174																				
ASA23U10	S55174-A153	7	1	75															Auxiliary switch for STA..	PVC	2-position	AC 230 V	AC/DC 24 V	
ASA23U20	S55174-A154		2	121																				
ASP23U10	S55174-A155	8	1	75	Auxiliary switch for STP..	PVC	2-position	AC 230 V	AC/DC 24 V										White					
ASP23U20	S55174-A156		2	121																				
ASY23L20LD	S55174-A157	9	2	70	LED			PVC			2-position	-	AC/DC 24 V	White										
ASY23L50LD	S55174-A158		5	129																				

Adapter

Type	Item NO.	For third-party valves	Description
AV533	S55174-A164	Danfoss RA2000	Plastic
AV63	S55174-A165	Giacomini	Plastic
AV59	AV59	Vaillant	-
AV64	S55174-A166	Pettinaroli M28x1,5	-
AV304	S55174-A167	Various (5 pieces)	Adapter set for installers
AV301	S55174-A159	Valves with M30 x 1.5	Higher bayonet adapter, 5 mm ¹⁾
AV302	S55174-A160	Valves with M28 x 1,5 - Comap - Markaryd - Herz	Higher bayonet adapter, 5 mm ¹⁾
AV303	S55174-A161	Valves with M30 x 1 - TA	Higher sliding sleeve adapter (bayonet), 5 mm ¹⁾

¹⁾ The insert is with or without a 5 mm extension depending on assembly.

Protection against dismantling	Type	Item no.	Description
	AL431	S55174-A168	Tamper-proof fitting to prevent dismantling of the actuator

Ordering

When ordering, specify the quantity, product name, and type code.

Example 1

1 actuator STA23 with 1 m connecting cable and
1 adapter AV533

Example 2

1 actuator STP73/00 without connecting cable,
1 connecting cable ASY23L50LD, 5 m length with LED operating indication,
operating voltage AC/DC 24 V, white
1 adapter AV533

Delivery

Actuators, valves and accessories are supplied in separate packages.

Equipment combinations

Siemens valve type	Actuator	Valve type	k_{vs} [m ³ /h]	\dot{V} [l/h]	PN class	Data sheet valve
VDN.., VEN.., VUN..	STA..	Radiator valves	0.09...1.41	–	PN 10	N2105, N2106
VPD.., VPE..	STA..	MCV MiniCombiValves	–	25...483		N2185
VD1..CLC..	STA..	Small valves	0.25...2.6	–		N2103
V..I46..	STA..	Zone valves	2...5	–	PN 16	N4842
V..P47..	STP..	Small valves	0.25...4	–		N4847
VPP46.., VPI46..	STA..	Combi valves	–	30...1330	PN 25	N4855

Third-party valves, connection M30 x 1.5, without adapter

Radiator valves	Small valves
• Heimeier	• TA type TBV-C
• Watts (Cazzaniga)	
• Oventrop M30 x 1.5 (as of 2001)	
• Honeywell-Braukmann	
• MGN	
Valves from additional manufacturers upon request	
Additional radiator valves with adapters AV.. see "Accessories/Adapter" page 5	

k_{vs} = Nominal flow value for cold water (5...30 °C) through a fully opened valve (H_{100}), at a differential pressure of 100 kPa (1 bar)

\dot{V} = Volumetric flow at 0.5 mm stroke

Technical notes

NO, NC valves

NO valves

- Valve is opened without actuator (Normally Open)
- The valve stem is fully extended
- Typical examples: Radiator valves (VDN.., VEN.., VUN..), small valves (VD1..CLC), zone valves (V..I46) and Combi valves (VP..).

NC valves

- Valve is closed without actuator (Normally closed)
- The valve stem is fully extended
- Example: Small valve V..P47..

Most third-party valves are NO valves.

Valve and actuator combination

NO function

- STA.. actuator stem is extended when de-energized.
- NC valve required.

NC function

- STA.. actuator stem is extended when de-energized.
- NO valve required.

Note

NO function
(Normally Open)

The valve is closed in a de-energized state for most valve applications featuring thermal actuators

Actuators with the opposite control action, are used when the reverse function is required: The valve is open in a de-energized state.

The following table displays the appropriate combinations.

Note

Response at de-energized actuator

Valve	Type	De-energized actuator	
		STA..	STP..
Radiator valves	VDN.., VEN.., VUN..	Closed	Open ¹⁾
Small valves	VP..47..	A ↔ AB open ¹⁾	A ↔ AB closed
	VD1..CLC	Closed	Open ¹⁾
Zone valves	V..I46..	AB ↔ A closed	AB ↔ A open ¹⁾
Combi valves	VPD.., VPE.. VPP46.., VPI46..	Closed	Open ¹⁾

¹⁾ Controller must support NO valve actuator combinations.

Technical and mechanical design

Actuator operation

The electrothermal actuators STA.. and STP.. are noise-free and maintenance-free. When the control signal is applied to the actuator, the temperature of the heating element rises, which causes the solid expansion medium to expand. It transfers its stroke directly to the installed valve.

The valve starts to open after preheating for approx. 1 min if the heating element is switched on in a cold state (room temperature), and achieves the maximum stroke after another approx. 2.5 min (230 V) or 3 min (24 V). At power-off, the expansion element cools down and the valve will be closed by the spring.

This has the following effect for the actuator types below:

STA73.., STA23.. (NC)
2-position, PDM

The actuator stem retracts and the radiator valve is opened by the own spring. The actuator stem extends when de-energized and the radiator valve is closed.

STP73.., STP23.. (NO)
2-position, PDM

The actuator stem extends and the small valve, V..P47.., is opened. The actuator stem retracts when de-energized and the small valve is closed by the own spring.

STA63..
STA73/00 with
DC 0...10 V module

The actuator stem retracts and the radiator valve is opened by the spring. The position of the stem is proportional to the DC 0...10 V positioning signal. The actuator stem extends when de-energized and the radiator valve is closed. The actuator deploys to the 50% stroke position if the positioning signal is lost when applying operating voltage.

DC 0...10 V actuators support various operation modes, see also under DIP-Switch settings

STP63..
STP73/00 with
DC 0...10 V module

The actuator stem extends and the small valve, V..P47.., is opened. The position of the stem is proportional to the DC 0...10 V positioning signal. The actuator stem retracts when de-energized and the small valve is closed by the own spring. The actuator deploys to the 50% stroke position if the positioning signal is lost when applying operating voltage.

DC 0...10 V actuators support various operation modes, see also under DIP-Switch settings

STP63../STP63..
DIP-switch settings

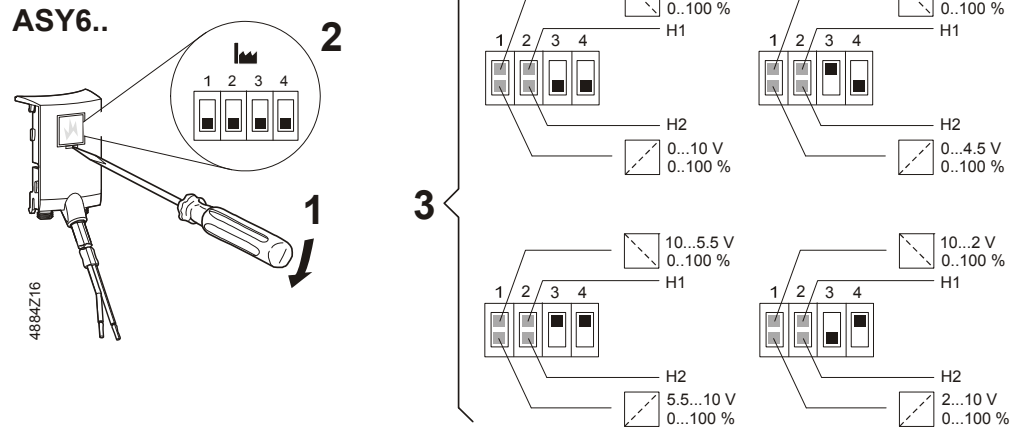

Position indication on
the actuator

The movement and actual position of the actuator is indicated by the gray interior part.

STA..

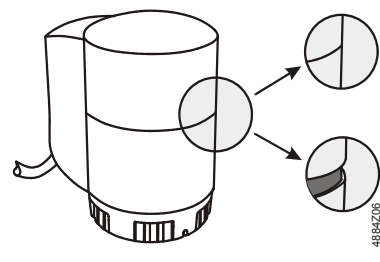

De-energized actuator

- The actuator's stem is extended
- The ¹valve is closed.

Actuator > 3 minutes with power

- The valve stem is retracted.
- The ¹valve is opened.

STP..

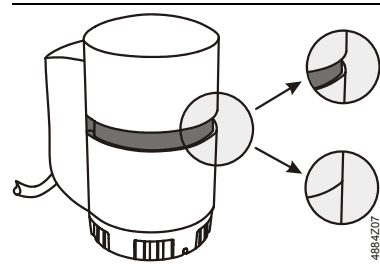

De-energized actuator

- The actuator's stem is retracted.
- The ²valve is closed.

Actuator > 3 minutes with power

- The actuator's stem is extended
- The ²valve is opened.

¹) With regard to radiator valves, VPP46../VPI46.. and VVI46../VXI46 .

²) With regard to V..P47..

Automatic adaption of
close - dimension

Locking the sliding sleeve, bayonet-ring, triggers the mechanical adaption of the close- dimension. This affects a pre-tensioning for NC types (STA..) on the valve stem resulting in a sealed valve. For NO types (STP..), the actuator stem will be positioned above the valve spindle without pre-tension.

Adaption of close-
dimension for STA..
actuators (NC)

Lies in the range between 8.5...13.5 mm ¹)

Adaption of close -
dimension for STP..
Actuators (NO)

Lies in the range between 12.5...17.5 mm ¹)

¹) when used with the supplied standard sliding sleeve

Adaption of close-dimension with higher sliding sleeve (bayonet-nut) AV301, AV302 und AV303, bayonet-nut, AV.. (Accessories)

A higher sliding sleeve, bayonet nut, is used in the following cases:

- a. If the diameter of the actuator's sliding sleeve, bayonet-ring (42,5 mm) prevents assembly (e.g. angle valves, valves with measurement ports) and
- b. To adapt to the desired thread size for third-party manufacturers (M28 x 1.5 or M30 x 1)

It must be combined with insert A (black) to avoid changing the close - dimension range using an higher sliding sleeve adapter (bayonet).

Options

- In order to achieve the close-dimension range, reduced by 5 mm, the sliding sleeve adapter must be used together with insert B (white).
- In order to achieve the close-dimension range, increased by 5 mm, the sliding sleeve adapter must be used without insert A or B.

An expansion to the close - dimension is required to adapt to third-party valves that do not operate within the standard close dimension range.

Close-dimension range with the different adapters:

	Standard bayonet-nut	Higher bayonet adapter AV301 → M30 x 1,5 AV302 → M28 x 1,5 AV303 → M30 x 1		
	No insert	Insert-A (black)	Insert-B (black)	No insert
STA..	8,5 ... 13,5	8,5 ... 13,5	3,5 ... 8,5	13,5 ... 18,5
STP..	12,5 ... 17,5	12,5 ... 17,5	7,5 ... 10,5	17,5 ... 22,5

Positioning times, Opening/closing

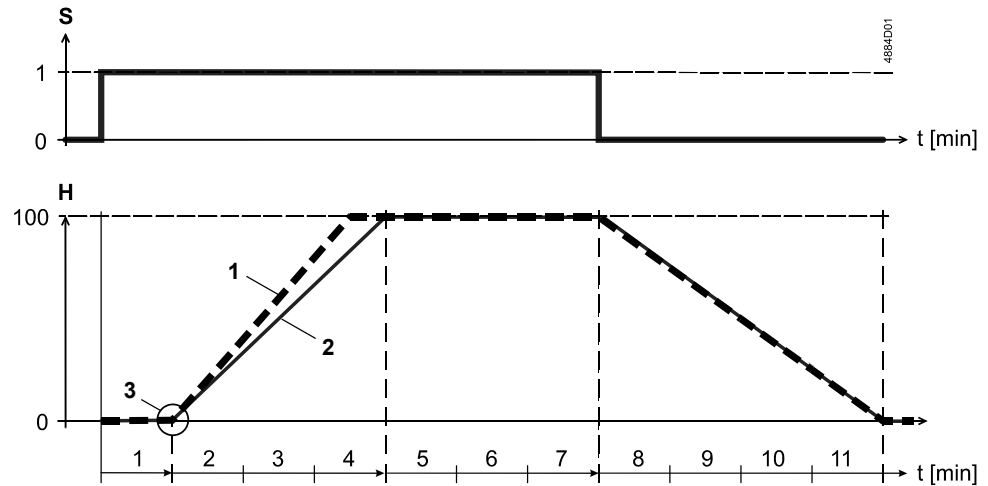

S Positioning signal

H Stroke in %

1 Actuator ST..2.. (AC 230 V)

2 Actuator ST..7.. (AC 24 V)

3 Warm start

– Values at 25° C (ambient temperature)

– The positioning time depends on the voltage and the ambient temperature

⚠ Warning

Some controllers drive the valve actuators with pulsed signals. This increases the response time. For optimal control, the ambient temperature of the actuator must be < 40°C.



Pulse-duration modulation

Accessories

Separate connecting cable

The actuators STA../00 and STP../00 are supplied without a connecting cable. They can be assembled as per the table "Accessories/connecting cables" on page 4. The product also includes halogen-free cable.

ASY23L..

Standard connecting cable for all STA.. and STP.. Actuators for open/close positioning signal AC 24 V or AC 230 V with PVC coating. Lengths 0.8...15 m.

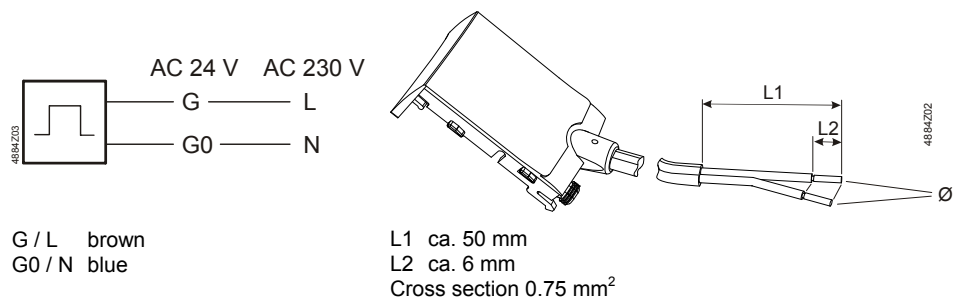

ASY6AL..

The connecting cables are available in various lengths, colors and coating quality with DC 0...10 V control module and AC 24 V voltage supply, can be combined with STA73/00 thermal actuators.

ASY6PL..

The connecting cables are available in various lengths, colors and coating quality with DC 0...10 V control module and AC 24 V voltage supply, can be combined with STA73/00 thermal actuators.

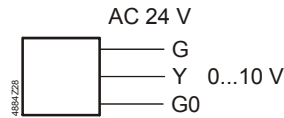

G braun
Y rot
G0 blau

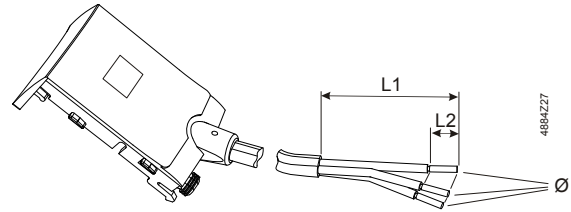

L1 ca. 50 mm
L2 ca. 6 mm
Querschnitt bis 2 m 0,5 mm², >2 m 0,75 mm²

ASA23U.. with aux. switch for **STA../00**
ASP23U.. with aux. switch for **STP../00**

Connecting cable with PVC coating and integrated auxiliary switch for all STA../00, STP../00 actuators for open/close positioning signal AC 24 V or AC 230 V. Lengths 1 or 2 m.

Switch power:

AC	DC
3 A resistive	4...30 V / 100 mA
2 A inductive	48 V / 1 A

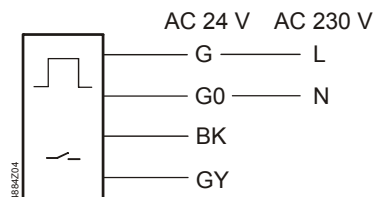

G brown
G0 blue
BK black
GY gray

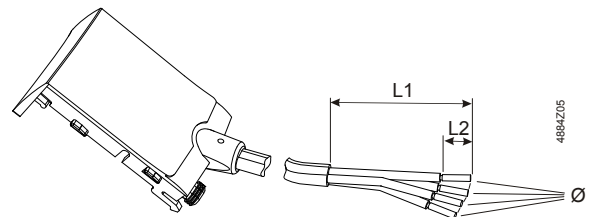

L1 ca. 50 mm
L2 ca. 6 mm
Cross section 0.5 mm²

ASY23..LD
with LED indicator

The same as AS..23U but for AC/DC 24 V only. The green LED is lit synchronously with the open/close control. It visually indicates control and provides support during commissioning and service. Lengths 1 or 2 m.

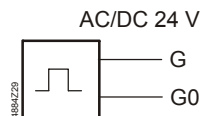

G brown
G0 blue

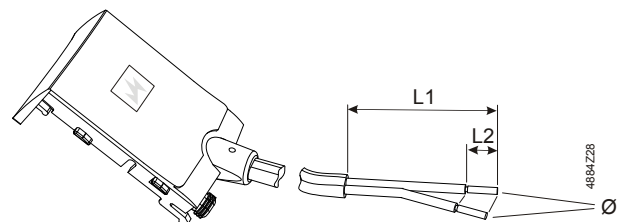

1 LED
L1 ca. 50 mm
L2 ca. 6 mm
Cross section 0.5 mm²

Adapter AV.. for third-party valves

Adapters are available for mounting the STA.. and STP.. actuators on valves from other manufacturers (see "Accessories/Adapters" on page 5).

Tamper-proof fitting AL431

Tamper-proof fittings can be used to prevent unauthorized intervention on the actuators.

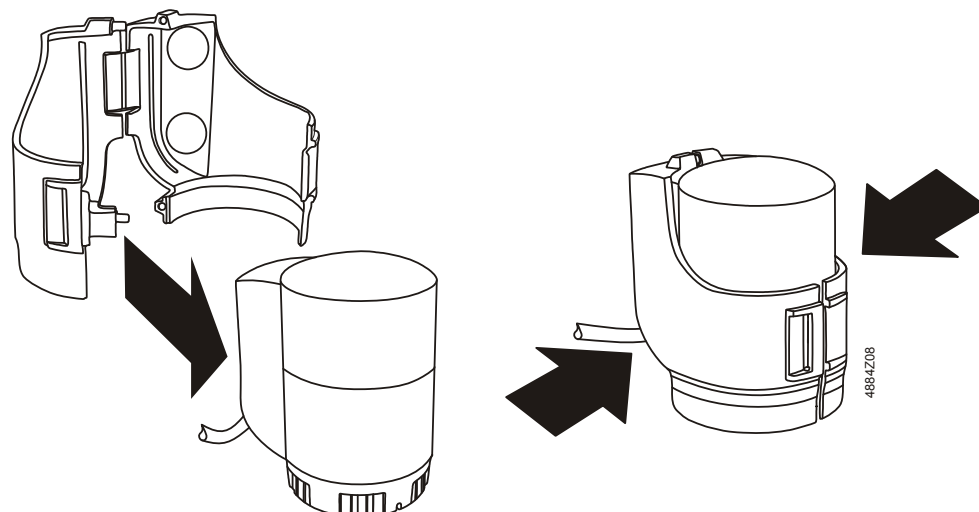

Mounting and installation notes

Mounting on valve

Mounting instructions are included in the packaging.

Actuators STA.. or STP.. are supplied as separate units. They can be assembled with just a few movements prior to commissioning:

- Remove the protective cover from the valve body
- Insert the sliding sleeve, bayonet-nut, on the valve and manually tighten
- Put actuator in position and manually tighten (clockwise) the bayonet-ring until a second click
- STA../00, STP../00: Plug in the connecting cable
- Connect to operating voltage only after mounting

Hints for the dismantling:

- Interrupt the power supply and disconnect the connection cable
- Wait for 6 min. until the actuator is cooled down
- Turn the sliding sleeve, bayonet-ring, counter clockwise to the end-position

At dismantling the actuator will be set automatically to the original position (factory setting).

Seldom may happen that the actuator will be released from the valve together with the valve whereby the bayonet-nut stuck in the actuator. In order to re-use the actuator, the actuator's stem has to be re-set to the original position (factory setting). For this purpose, turn the actuator up-side-down and push back the stem with simultaneous counter clock wise turning of the sliding sleeve, bayonet-ring, until latching.

Warning

Do not use pipe wrenches, spanners or similar!

Mounting positions

Actuators may be installed in all positions (IP54 standard guaranteed).

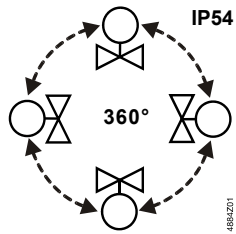

Notes on electrical installation

- Comply with all local regulations when installing.
- Connect the connecting cable downward and away from the bottom.
- Provide for a means to isolate from mains power/connecting voltage, e.g. by connecting an automatic circuit breaker or switch fuse upstream of the control unit.

Maintenance

The actuator is maintenance-free.

Repair

Disconnect the connecting cable from the operating voltage prior to replacing. Opening the actuator can cause irreparable damage. It may also result in injury from the installed, strong spring. The actuator cannot be repaired; the entire unit must be replaced.

Disposal



Do not dispose of the device in domestic waste. Legislation may demand special handling of certain components, or it may be sensible from an ecological point of view. **Observe all local, applicable laws.**

Warranty

The technical data relating to specific applications are valid only in conjunction with the valves listed under "Equipment combinations" in this data sheet on page "5".

When using STA.. and STP.. actuators, users are responsible for ensuring the proper functioning of actuators when used together with third-party valves; any guarantees on the part of Siemens Building Technologies expire accordingly.

Technical data

		STA73.. / STA73../00 STP73.. / STP73../00 STA73HD	STA23..., STA23../00 STP23..., STP23../00	STA63.. STP63..
Power supply	Operating voltage	AC/DC 24 V ± 20 % ¹⁾	AC 230 V ± 15 %	AC 24 V ± 20 %
	Frequency	50 / 60 Hz	50 / 60 Hz	50 / 60 Hz
	Power consumption at 50 Hz			
	Operation	2.5 W	2.5 W	2.5 W
	At power-up	6 VA	58 VA	6 VA
	Switch-on current (transient)	250 mA	250 mA	250 mA
	Primary fuse	External		
Signal input	Positioning signal	2-position, PDM ²⁾ DC 0...10 V ³⁾	2-position	DC 0...10 V
	Parallel operation of multiple actuators	For PDM ST...3PR	May be limited by the controller's output power	
Operating data	Positioning time at 20 °C, 50 Hz	270 s	210 s	30 s
	Positioning force	100 N		
	Nominal stroke	Min. 3 mm		Up to 4.5 mm (adjustable to max. 3 mm ⁴⁾)
	Permissible temperature of medium in the connected valve	1...110 °C		
	Actuator stem for "de-energized actuator"	STA.. extended STP.. closed		
	Radiator valves (e.g. VD..)	See "Equipment combinations" on page 5.		
	Small valves (V..P47..)			
	Zone valves (V..I46..)			
	Maintenance			
	Electrical connection	Cable length	See page 3, "Type summary" or page 4 and page 15, "Connecting cables"	
Cross section ⁵⁾		Strands 2 x 0.5 mm ²	Strands 2 x 0.75 mm ²	Strands 2 x 0.5 mm ²
Mounting	Attached to the valve	Bayonet-nut/-ring M30 x 1.5; – see also under adapters		
	Mounting position	Any, 360°		
Colors	Cover	White, RAL 9016, STA..B/00 and STP..B/00 black, RAL 9005		
	Lower part	STA.. light gray, RAL 7035, STP.. Traffic gray, RAL 7042 STA..B/00 and STP..B/00 black, RAL 9005		
	Connecting cables	See "Connecting cables" on page 4 and page 15		
Standard for actuators and connecting cables	CE conformity			
	As per EMC directive:	2004/108/EC		
	Immunity	EN 61000-6-1 Residential		
	Emissions	EN 61000-6-3 Residential		
	Electrical safety	SELV (PELV as per IEC 60364-4-41)		
	Low-voltage directive	2006/95/EC		
	Protection class as per	EN 60730 Class III	EN 60730 Class II	EN 60730 Class III
	Degree of pollution	As per EN 60730 class II		
	Housing type	IP54 as per EN 60529		
	Environmental compatibility	ISO 14001 (environment) ISO 9001 (quality) SN 36350 (Environmentally compatible products) RL 2002/95/EC (RoHS)		
Dimensions Weight	Dimensions	See "Dimensions" on page 15		
	Actuator weight	See table "Type summary" actuators with and without connecting cable on page 3.		
	Weight of connecting cable ASY..	See table Accessories page 4		
Materials STA..., STP.. Conn. cables	Cover and lower part	Polycarbonate		
	ASY..., ASP..	PVC		
	ASY..HF	Halogen-free as per VDE 0207-24		

¹⁾ Permitted for safety extra-low voltage only (SELV, PELV)

²⁾ PDM = Pulse-duration modulation

³⁾ STA73/00, STA73MP/00 and STA73B/00, with connecting cable ASY6AL..
STP73B/00 STP73/00 and with connecting cable ASY6PL..

⁴⁾ Can be set using the DIP switch under the cover on the connecting cable. See Mounting instructions M4884

⁵⁾ Separate cable, see page 15

General ambient conditions

	Operation EN 60721-3-3	Transportation EN 60721-3-2	Storage EN 60721-3-1
Temperature	5...50 °C	-20...60 °C	5...50 °C
Temperature for quasi-continuous control	5...40 °C	-	-
Humidity	< 85 % r.h.	< 95% r.h.	5...100 % r.h.

Connecting cables

Connecting cables w/o 0...10 V module

	ASY23..	ASY23..B	ASY23..HF	ASY23..LD	ASA23..	ASP23..
Length [m]	0.8...15	3...10	2...10	2 / 5	1 / 2	1 / 2
Cross section [mm ²]	≤ 2 m: 0.50	0.75	0.75	1 m: 0.50	0.50	0.50
	> 2 m: 0.75			5 m: 0.75		
Operating voltage [V]	24 / 230 ¹⁾	24 / 230 ¹⁾	24 / 230 ¹⁾	24	24 / 230 ¹⁾	24 / 230 ¹⁾
Housing color	White, RAL 9016	Black, RAL 9005	White, RAL 9016	White, RAL 9016	White, RAL 9016	White, RAL 9016
Coating	PVC	PVC	Halogen-free	PVC	PVC	PVC
Auxiliary switch	-	-	-	-	x	x
Indicator	-	-	-	LED	-	-
Weight	See Table on page 4					

¹⁾ AC 230 V with STA23../STP23.., AC/DC 24 V with STA73../STP73..

Connecting cables with 0...10 V module

	ASY6A..			ASY6P..		
	ASY6A..	ASY6A..B	ASY6A..HF	ASY6P..	ASY6P..B	ASY6P..HF
Length [m]	2 / 5 / 7	2 / 5 / 7	2 / 5 / 7	2 / 5 / 7	2	2 / 5 / 7
Cross section [mm ²]	0.22	0.22	0.22	0.22	0.22	0.22
Operating voltage [V AC]	24	24	24	24	24	24
Color	White, RAL 9016	Black, RAL 9005	White, RAL 9016	White, RAL 9016	Black, RAL 9005	White, RAL 9016
Coating	PVC	PVC	Halogen-free	PVC	PVC	Halogen-free
Signal	0...10 V	0...10 V	0...10 V	0...10 V	0...10 V	0...10 V
Interior resistance Ri	100 kΩ	100 kΩ	100 kΩ	100 kΩ	100 kΩ	100 kΩ
Weight	See Table on page 4					

Dimensions

Dimensions in mm

STA..

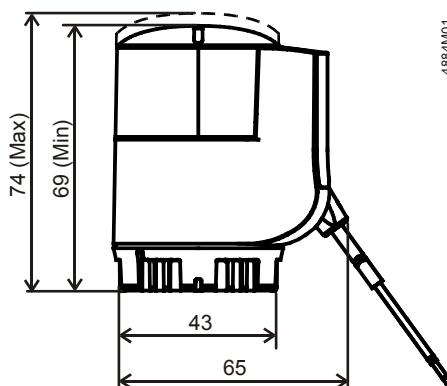

STP..

